

Varenummer: 20343550M12KS
Beskrivelse: E+G Justerfod
GN 343.5-50-M12-KS

Mål

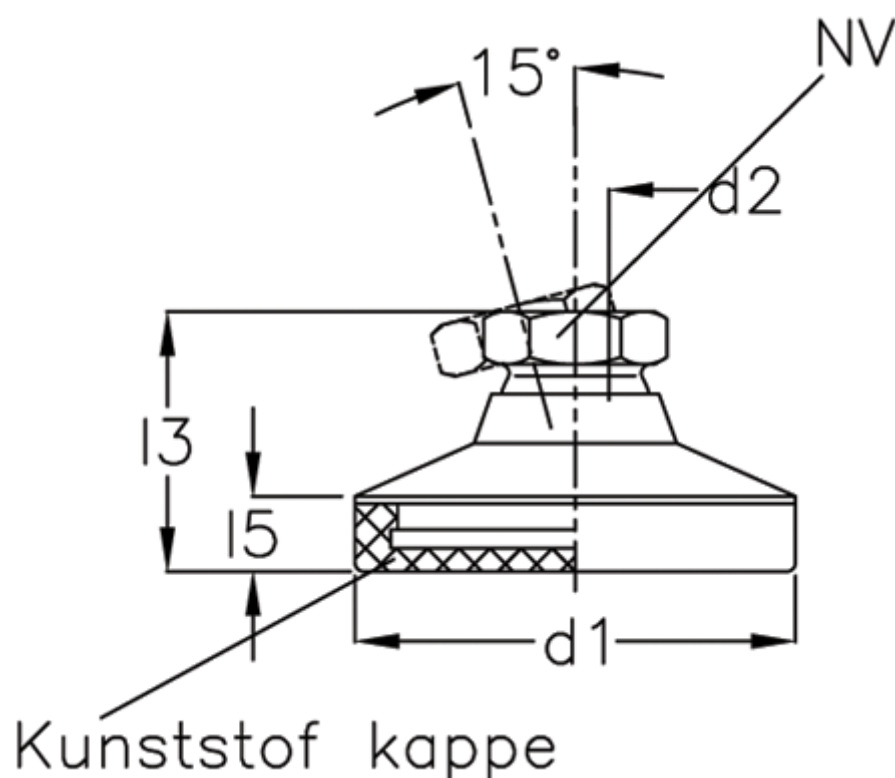

d1	= 50
d2	= 12
l3	= 29.5
l5	= 8.5
NV	= 17
Statisk belastning (N)	= 16
t min	= 11.5